

CDN

Coupling / Decoupling Network

IEC / EN 61000-4-6

IEC 61326-3-2, Ne-21

- Coupling / Decoupling networks for the following frequencies:
150 kHz – 230 MHz:
Norm IEC / EN 61000-4-6
- Coupling / Decoupling networks for the following frequencies:
10 kHz – 230 MHz:
Norm IEC / EN 61000-4-6
IEC 61326-3-2, NE-21



Coupling networks for different applications.
Special versions on request!

Overview

Coupling / decoupling networks (**CDN's**) are used for immunity tests to conducted disturbances induced by radio frequency fields according to IEC / EN 61000-4-6 and other.

A number of different types are available for different applications.

We also produce special models on customer request!

Key Facts

Field of application	Examples	Types
Unscreened supply lines (mains)	AC grid, direct current in industrial plants, ground connection	CDN-M
Unscreened unbalanced interconnection lines	Audio cable SPS lines	CDN-AF
Unscreened balanced interconnection lines	Communication lines	CDN-T CDN-RJ
BUS-lines	CAN BUS	CAN-BUS
Shielded connecting cables	HDMI, coaxial cable, cable for LAN- and USB connections	CDN-S RJ45S USB HDMI Firewire

Detailed description by type number – refer to the following pages



CDN

Coupling / Decoupling Network

CDN AF

- Coupling / decoupling of interference signals on unshielded, unbalanced lines



CDN AF 5-MC - EUT-side



CDN AF 5-MC - AE-side

Technical data (depending on model, see page 3)

Article	CDN AF xx * (Terminal block)	CDN AF xx – MC * (with safety sockets)
RF In		
Frequency range (RF In)	(10 kHz) 150 kHz - 80 MHz / 230 MHz	
Power Rating (RF In)	6 W (100 % ED)	6 W (100 % ED)
Decoupling attenuation (RF In – AE)	> 20 dB (150 kHz – 230 MHz) > 40 dB (1 MHz – 100 MHz)	> 20 dB (150 kHz – 230 MHz) > 40 dB (1 MHz – 100 MHz)
Insertion loss (RF In – EUT)	10 dB ± 1 dB (150 kHz – 80 MHz)	10 dB ± 1 dB (150 kHz – 80 MHz)
	10 dB + 3 dB (150 kHz – 230 MHz)	10 dB + 3 dB (150 kHz – 230 MHz)
Connector	BNC	BNC
EUT / AE		
Maximum input voltage	100 VAC / 150 VDC	100 VAC / 150 VDC
Current rating (AE – EUT)	0,5 - 5 A (depending on model, s. page 3)	0,5 - 5 A (depending on model, s. page 3)
Insertion loss (AE – EUT)	< 1dB (DC – 100 kHz)	< 1dB (DC – 100 kHz)
Connectors	terminal block	4 mm MC socket
Mechanical data		
Dimensions (W x H x D)	160 x 84,5 x 240 mm	160 x 84,5 x 240 mm

* _10 available, frequency range 10 kHz – 230 MHz

Circuit diagram

Circuit diagram CDN AF2

(Principle valid for CDN AF2, AF3, AF4 and AF5).

For CDN AF6, AF7, AF8, AF9, AF10 and AF12, capacitors C2 are eliminated.

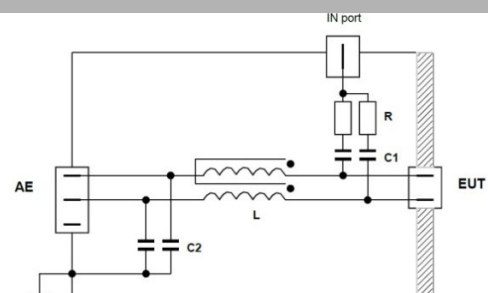

CDN

Coupling / Decoupling Network

Models	Current rating AE – EUT (A)	Input voltage		Frequency range RF In				Case size		Connectors			
		AC (V)	DC (V)	10 kHz – 80 MHz	10 kHz – 230 MHz	150 kHz – 80 MHz	150 kHz – 230 MHz	1 160 x 84,5 x 240 mm	2 200 x 122,5 x 400 mm	4 mm MC safety sockets	Terminal block	9 pol. Sub-D female	15 pin. Sub-D female
Article CDN XX													
AF2	1	100	150				x	x		x			
AF2-MC	5	100	150				x	x		x			
AF2-MC_10	5	100	150		x			x		x			
AF3	1	100	150				x	x			x		
AF3-MC	5	100	150				x	x		x			
AF3-MC_10	5	100	150		x			x		x			
AF4	1	100	150				x	x			x		
AF4-MC	5	100	150				x	x		x			
AF4-MC_10	5	100	150		x			x		x			
AF5	1	100	150				x	x			x		
AF5-MC	5	100	150				x	x		x			
AF5-MC_10	5	100	150		x			x		x			
AF6	1	100	150				x	x			x		
AF8	1	100	150				x	x			x		
AF8-SUB9D_10	0,5	100	150		x			x				x	
AF8-SUB15D	0,5	100	150				x	x					x
AF9	1	100	150				x	x			x		
AF10	1	100	150				x	x			x		
AF12-SUB15D	0,5	100	150				x	x					x



CDN

Coupling / Decoupling Network

Calibration adaptor for CDN AF 2-5

For the CDN AF 2-5 types, the 150 Ohm termination (AE side) is required by the standard, but the calibration values for these CDN types are almost independent of the load.

This is due to the fact that these types have capacitors to ground at the AE terminal, which create an RF short circuit. This means that the 150 Ohm load at the accessory equipment (AE) connection could also be dispensed with for the CDN AF 2-5.

Calibration adaptor – Order number

AF-type	Article	AF-type	Article
AF 2	CDG A 3102	AF5-MC	CDG A 3128 – EUT-port
AF 2-MC	CDG A 3101	AF5-MC_10	CDG A 3107 – AE-port
AF 2-MC_10	CDG A 3101	AF6	CDG A 3134
AF 3	CDG A 3133	AF8	CDG A 3110
AF 3-MC	CDG A 3101	AF8-SUB9D_10	CDG A 3131
AF 3-MC_10	CDG A 3101	AF8-SUB15D	CDG A 3143
AF4	CDG A 3108	AF9	CDG A 3119
AF4-MC	CDG A 3128 – EUT-port	AF10	CDG A 3135
AF4-MC_10	CDG A 3107 – AE-port	AF12-SUB15D	CDG A 3145
AF5	CDG A 3114	Montageplatte mit 50/ 150 Ohm Übergang	CDG A 3100



CDN

Coupling / Decoupling Network

CDN M

- Coupling / decoupling of interference signals on power supply lines AC + DC
- Nominal voltage up to 1000 V
- Rated current up to 100 A

Illustration
CDN M2 + M3



Technical data			
Article	CDN M1/M2/M3/M4/M5 - M2+M3 -16A / 32A	CDN M2/M3/M4/M5 -32A-HV (VHV)	CDN M2/M3/M4/M5 -63A-100A-HV
RF In			
Frequency range (RF In)	(10 kHz) 150 kHz– 80 MHz / 230 MHz		
Power rating (RF In)	6 W (100 % ED)		
Decoupling attenuation (RF In – AE)	> 30 dB (150 kHz – 80 MHz)	> 30 dB (150 kHz – 80 MHz)	> 30 dB (150 kHz – 80 MHz)
	> 20 dB (80 MHz – 230 MHz)	> 15 dB (80 MHz – 230 MHz)	> 15 dB (80 MHz – 230 MHz)
Insertion loss (RF In – EUT)	10 dB +2/-1 dB (150 kHz – 80 MHz)	10 dB +2/-1 dB (150 kHz – 80 MHz)	10 dB +2/-1 dB (150 kHz – 80 MHz)
	10 dB + 5 dB (80 MHz – 230 MHz)	10 dB + 5 dB (80 MHz – 230 MHz)	10 dB + 5 dB (80 MHz – 230 MHz)
Connector	BNC	BNC	BNC
EUT / AE			
Max input range AC (L-PE)	280 V	600 V (1000 VHV)	600 V
Max. input voltage DC	485 V	1000 V	1000 V
Max. input voltage	500 V	1000 V	1000 V
Current rating (AE – EUT)	16 A / 32 A / 63 A / 100 A; (M1 / M2+3 I _{PE} <0.5 A)		
Insertion loss (AE – EUT)	< 1 dB (DC – 100 kHz)		
Connector	4 mm MC safety sockets	4 mm MC safety sockets	6 mm sockets (incl. the necessary safety test lines)
Mechanical data			
Dimensions (W x H x D)	160 x 84,5 x 240 mm	200 x 122,5 x 400 mm	200 x 122,5 x 400 mm

Circuit diagram

Circuit diagram CDN M3

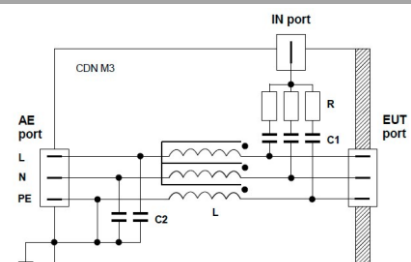

CDN

Coupling / Decoupling Network

Models	Nennstrom (AE-EUT) (A)	Input voltage		Frequency range RF In				Terminal assignment	Case size		Connector	
		AC (V)	DC (V)	10 kHz – 80 MHz	10 kHz – 230 MHz	150 kHz – 80 MHz	150 kHz – 230 MHz		160 x 84,5 x 240 mm	200 x 122,5 x 400 mm	4 mm MC safety sockets	6 mm round connectors (incl. assembled test leads)
Article CDN XX								1	2			
M1-16	16	280	485				x	PE	x		x	
M1-16_10	16	280	485		x			PE	x		x	
M1-L16	16	280	485				x	L	x		x	
M1-L32	32	280	485				x	L	x		x	
M2-16	16	280	485				x	L, N	x		x	
M2-16_10	16	280	485		x			L, N	x		x	
M2-32	32	280	485				x	L, N	x		x	
M2-32_10	32	280	485		x			L, N	x		x	
M2-32 HV	32	600	1000			x		L, N		x	x	
M2-63 HV	63	600	1000			x		L, N		x	x	
M2-100 HV	100	600	1000			x		L, N		x	x	
M2+M3-16	16	280	485				x	L, N, PE	x		x	
M2+M3-16_10	16	280	485		x			L, N, PE	x		x	
M2+M3-32	32	280	485				x	L, N, PE	x		x	
M3-16	16	280	485				x	L, N, PE	x		x	
M3-L16	16	280	485				x	3 x L	x		x	
M3-16_10	16	280	485		x			L, N, PE	x		x	
M3-32	32	280	485				x	L, N, PE	x		x	
M3-32_10	32	280	485		x			L, N, PE	x		x	
M3-L32	32	280	485				x	3 x L	x		x	
M3-L32_10	32	280	485		x			3 x L	x		x	
M3-LN32	32	280	485				x	L1, L2, N	x		x	
M3-32 HV	32	600	1000			x		L, N, PE		x	x	
M3-L32 HV	32	600	1000			x		3 x L		x	x	
M3-63 HV	63	600	1000			x		L, N, PE		x	x	
M3-100 HV	100	600	1000			x		L, N, PE		x	x	
M3-L100 HV	100	600	1000			x		3 x L		x	x	
M4-16	16	280	485				x	3x L, PE	x		x	
M4-N16	16	280	485				x	3x L, N	x		x	
M4-32	32	280	485				x	3x L, PE	x		x	
M4-N32	32	280	485				x	3x L, N	x		x	
M4-N32 HV	32	600	1000			x		3x L, N	x		x	
M4-32_10	32	280	485		x			3x L, PE	x		x	
M4-32 HV	32	600	1000			x		3x L, PE		x	x	
M4-N63 HV	63	600	1000			x		3x L, N		x	x	
M4-63 HV	63	600	1000			x		3x L, PE		x	x	
M4-100 HV	100	600	1000			x		3x L, PE		x	x	
M4-N100 HV	100	600	1000			x		3x L, N		x	x	



CDN

Coupling / Decoupling Network

Models	Nennstrom (AE-EUT) (A)	Input voltage		Frequency range RF In				Terminal assignment	Case size		Connector	
		AC (V)	DC (V)	10 kHz – 80 MHz	10 kHz – 230 MHz	150 kHz – 80 MHz	150 kHz – 230 MHz		160 x 84,5 x 240 mm	200 x 122,5 x 400 mm	4 mm MC safety sockets	6 mm round connectors (incl. assembled test leads)
Article CDN XX									1	2		
M5-16	16	280	485				x	3x L, N, PE	x		x	
M5-32	32	280	485				x	3x L, N, PE	x		x	
M5-32_10	32	280	485		x			3x L, N, PE	x		x	
M5-32 HV	32	600	1000			x		3x L, N, PE		x	x	
M5-32 VHV	32	1000	1000			x		3x L, N, PE		x	x	
M5-63 HV	63	600	1000			x		3x L, N, PE		x		x
M5-100 HV	100	600	1000			x		3x L, N, PE		x		x



CDN

Coupling / Decoupling Network

Calibration adaptor for CDN M



For CDN M-types, the 150 Ohm termination (AE side) is required by the standard, but the calibration values for these CDN types are almost independent of the load.

This is due to the fact that M-types have capacitors connected to ground on the AE side, which create an RF short circuit. Therefore, those CDN M do not really require the 150 Ohm load on the AE side.

Calibration adaptor – Order number

M-type	Article	M-type	Article
M1*	CDG A 3101	M4-16	CDG A 3107 (AE-port) CDG A 3128 (EUT-port)
L1-16	CDG A 3101	M4-N16	CDG A 3107 (AE-port) CDG A 3128 (EUT-port)
L1-32	CDG A 3101	M4-32*	CDG A 3107 (AE-port) CDG A 3128 (EUT-port)
M2-16*	CDG A 3101	M4-N32	CDG A 3107 (AE-port) CDG A 3128 (EUT-port)
M2-32*	CDG A 3101	M4-32 HV	CDG A 3125
M2-32 HV	CDG A 3125	M4-N63 HV	CDG A 3125
M2-63 HV	CDG A 3125	M4-63 HV	CDG A 3125
M2-100 HV	CDG A 3126	M4-100 HV	CDG A 3116
M2+M3-16*	CDG A 3101	M4-N100 HV	CDG A 3116
M2+M3-16_10	CDG A 3101	M5-16	CDG A 3107 (AE-port) CDG A 3128 (EUT-port)
M2+M3-32	CDG A 3101	M5-32*	CDG A 3107 (AE-port) CDG A 3128 (EUT-port)
M3-16*	CDG A 3101	M5-32 HV	CDG A 3125
M3-L16	CDG A 3101	M5-32 VHV	CDG A 3125
M3-32*	CDG A 3101	M5-63 HV	CDG A 3125
M3-L32*	CDG A 3101	M5-100 HV	CDG A 3116
M3-LN32	CDG A 3101	Mounting plate with 50/150 Ohm adaptor	CDG A 3100
M3-32 HV	CDG A 3125		
M3-63 HV	CDG A 3125		
M3-100 HV	CDG A 3126		

* version X_10 available, frequency range 10 kHz – 230 MHz



CDN

Coupling / Decoupling Network

CDN RJ

- Coupling / decoupling of interference signals on unshielded, balanced lines



Technical data		
Article	CDN RJ 11	CDN RJ 45*
RF In		
Frequency range (RF In)	(10 kHz) 150 kHz – 80 MHz / 230 MHz	
Power rating (RF In)	6 W (continuous)	6 W (continuous)
Decoupling attenuation (RF In – AE)	> 20 dB (150 kHz – 230 MHz)	> 20 dB (150 kHz – 230 MHz)
Insertion loss (RF In – EUT)	10 dB ± 1 dB (150 kHz – 80 MHz) 10 dB + 3 dB (80 MHz – 230 MHz)	10 dB ± 1 dB (150 kHz – 80 MHz) 10 dB + 3 dB (80 MHz – 230 MHz)
Connector	BNC	BNC
EUT / AE		
Maximum input voltage	100 VAC / 150 VDC	100 VAC / 150 VDC
Current rating (AE – EUT)	1,5 A	1,5 A
Insertion loss (AE – EUT)	< 1 dB (DC – 10 kHz) < 10 dB (10 MHz – 100 MHz)	< 1 dB (DC – 10 kHz) < 10 dB (10 MHz – 100 MHz)
Connector	RJ 11 socket	RJ 45 socket
Mechanical data		
Dimensions (W x H x D)	160 x 84,5 x 240 mm	160 x 84,5 x 240 mm

* version X_10 available, frequency range 10 kHz – 230 MHz

Circuit diagram

Circuit diagram CDN RJ11

(similar to CDN RJ45, 8 pins)

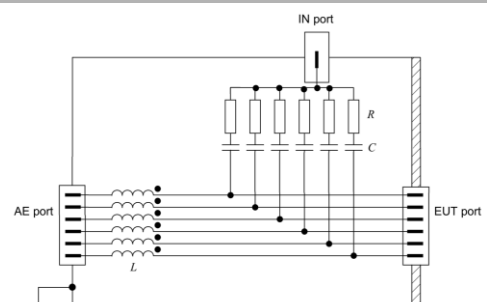

Calibration adaptor – Order number

RJ-Typ	Article
RJ 11	CDG A 3120
RJ 45 (see figure)	CDG A 3118
Mounting plate with 50/150 Ohm adaptor	CDG A 3100



CDN

Coupling / Decoupling Network

CDN T

- Coupling / decoupling of interference signals on unshielded, balanced lines

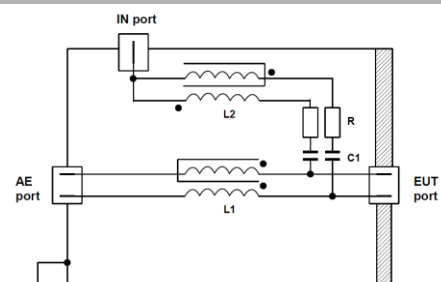

Illustration similar T4

Technical data		
Article	CDN T2, T4, T8	CDN T2_10, T4_10, T8_10
RF In		
Frequency range (RF In)	150 kHz – 230 MHz	10 kHz – 230 MHz
Power rating (RF In)	6 W (continuous)	6 W (continuous)
Decoupling attenuation (RF In – AE)	> 20 dB (150 kHz – 230 MHz)	> 20 dB (150 kHz – 230 MHz)
Insertion loss (RF In – EUT)	10 dB ± 1 dB (150 kHz – 230 MHz)	10 dB ± 1 dB (150 kHz – 230 MHz)
Connector	BNC	BNC
EUT / AE		
Maximum input voltage AC	100 V	100 V
Maximum input voltage DC	150 V	150 V
Current rating (AE – EUT)	0,5 A	0,5 A
Insertion loss (AE – EUT)	< 1 dB (DC – 1 MHz) < 10 dB (1 MHz – 100 MHz)	< 1 dB (DC – 1 MHz) < 10 dB (1 MHz – 100 MHz)
Connector	terminal clamp (T2, T4), RJ45 female (T8)	
Mechanical data		
Dimensions (B x H x T)	160 x 84,5 x 240 mm	160 x 84,5 x 240 mm

Circuit diagram

Circuit diagram CDN T2



Calibration adaptor – Order number

T-type	Article
T 2 (also T 2_10) (terminal block)	CDG A 3102
T 4 (also T 4_10) (terminal block)	CDG A 3112
T 8 (also T 8_10) (RJ 45 male)	CDG A 3118
Mounting plate with 50/150 Ohm adaptor	CDG A 3100

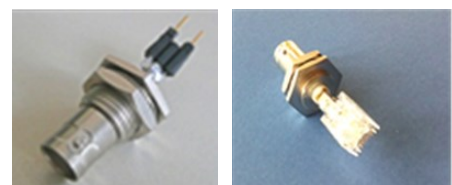

CDN

Coupling / Decoupling Network

CDN CAN-BUS

- Coupling / decoupling of interference signals on bus lines



Technical data		
Article	CDN CAN BUS L5*	CDN CAN BUS L4*
RF In		
Frequency range (RF In)	150 kHz - 230 MHz	
Power rating (RF In)	6 W (continuous)	
Decoupling attenuation (RF In – AE)	PIN 2+7: > 35 dB (150 kHz – 230 MHz) PIN 3+6+9: > 35 dB (150 kHz – 200 MHz) > 25 dB (200 MHz – 230 MHz)	PIN 2+7: > 35 dB (150 kHz – 230 MHz) PIN 3+9: > 35 dB (150 kHz – 200 MHz) > 25 dB (200 MHz – 230 MHz)
Insertion loss (RF In – EUT)	10 dB ± 1 dB (150 kHz – 230 MHz)	
Connector	BNC	BNC
EUT / AE		
Max. input voltage AC	50 V	50 V
Max. input voltage DC	50 V	50 V
Current rating (AE – EUT)	PIN 2+7 = 0,5 A PIN 3+6+9 = 3 A	PIN 2+7 = 0.5 A; PIN 3+9 = 3 A
Insertion loss (AE – EUT)	PIN 2+7: < 1 dB (DC – 10 MHz), < 10 dB (10 MHz – 500 MHz) PIN 3+6+9: < 1 dB (DC – 100 kHz)	PIN 2+7: < 1 dB (DC – 10 MHz) < 10 dB (10 MHz – 500 MHz) PIN 3+9: < 1 dB (DC – 100 kHz)
Connector	9-pol Sub-D female	9-pol Sub-D female
Mechanical data		
Dimensions (W x H x D)	160 x 84,5 x 240 mm	160 x 84,5 x 240 mm

* version X_10 available, frequency range 10 kHz – 230 MHz

Circuit diagram

Circuit diagram CDN CAN BUS (L5)

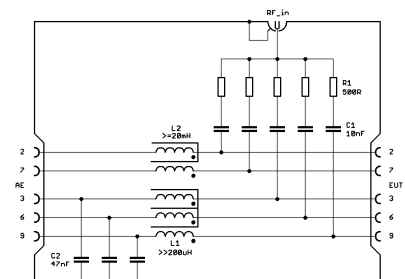

Calibration adaptor – Order number

CAN-type	Article
CAN-BUS	CDG A 3131 (9 pin male Sub-D)
Mounting plate with 50/150 Ohm adaptor	CDG A 3100



CDN

Coupling / Decoupling Network

CDN S

- Coupling / decoupling of interference signals on shielded cables

Device for direct coupling available (without decoupling network), see CDN D 100



Technical data (additional versions see following page)

Article	CDN S1	CDN S1-75*	CDN S2	CDN S4	CDN S8	CDN S9	CDN S15	CDN S25
EUT / AE								
Connector EUT	BNC fem.	BNC fem.	XLR male	5 pin male XLR	8 pin ma. Mini-DIN	9 pin male	15 pin ma. Sub-D	25 pin ma. Sub-D
Connector AE	BNC fem.	BNC fem.	XLR fem.	5 pin fem. XLR	8 pin fem. Mini-DIN	9 pin female	15 pin fem. Sub-D	25 pin fem. Sub-D
Max. input voltage	150 VAC / 200 VDC							
Current rating (AE – EUT)	1.5 A							
Insertion loss (AE – EUT)	< 1 dB (0 – 10 MHz) < 10 dB (10 MHz – 500 MHz)							
RF In								
Frequency range (RF In)	150 kHz – 230 MHz							
Power rating (RF In)	6 W (continuous)							
Decoupling attenuation (RF In – AE)	> 35 dB (150 kHz – 80 MHz) > 30 dB (80 MHz – 230 MHz)							
Insertion loss (RF In – EUT)	10 dB ± 1 dB (150 kHz – 80 MHz); 10 dB + 3 dB (80 MHz – 230 MHz)							
Connector	BNC							
Mechanical data								
Dimensions (W x H x D)	160 mm x 84.5 mm x 240 mm							

* CDN S1_75: 75 Ohm

Circuit diagram

Circuit diagram CDN S1

The interference signal transmitted via a 100 Ω resistor, is coupled to the cable shield.

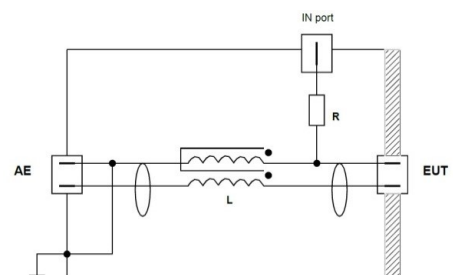

CDN

Coupling / Decoupling Network

Models	EUT / AE		RF-In Frequency range		Unscreened lines
	Connector EUT	Connector AE	150 kHz - 230 MHz	10 kHz - 230 MHz	
S1	BNC female	BNC female	x		1
S1_10	BNC female	BNC female		x	1
S1_75	BNC female	BNC female	x		1
S2	XLR male	XLR female	x		2
S2_10	XLR male	XLR female		x	2
S3_10	XLR male	XLR female		x	3
S4	5-pin male XLR	5- pin male XLR	x		4
S8	8-pin male Mini-DIN	8- pin female Mini-DIN	x		8
S9	9-pin male	9- pin female	x		9
S9_10	9-pin male	9- pin female		x	9
S15	15-pin male Sub-D	15-pin female Sub-D	x		15
S15_10	15-pin male Sub-D	15-pin female Sub-D		x	15
S25	25-pin male Sub-D	25-pin female Sub-D	x		25
S37	25-pin male Sub-D	25-pin female Sub-D	x		37

Calibration adaptor – Order number (Only needed on EUT-side!)

S-Typ	Article
S 1*	CDG A 3103
S 1-75	CDG A 3103
S 2*	CDG A 3104
S 3_10	CDG A 3124
S 4	CDG A 3130
S 8	CDG A 3129
S 9*	CDG A 3105 (9 pin female Sub-D)
S 15*	CDG A 3113 (15 pin female Sub-D)
S 25	CDG A 3106 (25 pin female Sub-D)
S 37	CDG A 3132
Mounting plate with 50/150 Ohm adaptor	CDG A 3100



* CDN SX_10 available



CDN

Coupling / Decoupling Network

CDN RJ 45 S / HDMI 1.4 / FireWire

- Coupling / decoupling of interference signals on shielded cables



Technical data			
Article	CDN RJ 45 S*	CDN HDMI 1.4*	CDN FireWire
RF In			
Frequency range (RF In)	150 kHz – 230 MHz		
Power rating (RF In)	6 W (permanent power)		
Decoupling attenuation (RF In – AE)	> 30 dB (150 kHz – 230 MHz)	> 50 dB (150 kHz – 80 MHz) > 25 dB (80 MHz – 230 MHz)	
Insertion loss (RF In – EUT)	10 dB ± 1 dB (150 kHz – 80 MHz) 10 dB + 3 dB (80 MHz – 230 MHz)		
Connector	BNC		
EUT / AE			
Max. input voltage	100 VAC / 150 VDC	100 VAC / 150 VDC	100 VAC / 150 VDC
Current rating (AE – EUT)	1,0 A	0,5 A	0,5 A
Insertion loss (AE – EUT)	< 0.3 dB (DC – 10 MHz) < 1 dB (10 MHz – 100 MHz) < 3 dB (100 MHz – 500 MHz)	< 1 dB (DC – 10 MHz) < 10 dB (10 MHz – 500 MHz)	
Connectors	shielded RJ45 jack	HDMI 19 pin	FireWire 6 pin
Mechanical data			
Dimensions (W x H x D)	160 mm x 84.5 mm x 240 mm		

* additional version X_10 available, frequency range 10 kHz – 230 MHz

Circuit diagram

Circuit diagram CDN

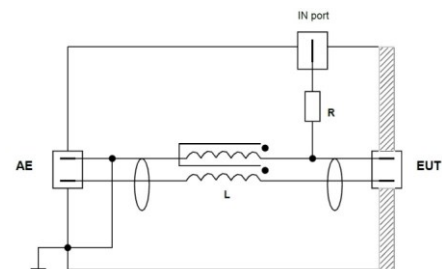

Calibration adaptor – Order number (Only needed on EUT-side!)

CDN-type	Article
RJ 45 S / RJ 45 S_10	CDG A 3117
HDMI (see figure)	CDG A 3123
FireWire	CDG A 3127
Mounting plate with 50/150 Ohm adaptor	CDG A 3100



CDN

Coupling / Decoupling Network

CDN
USB-2.0 / -Z / -Z_10 / -P / -P_10

- Coupling / decoupling of interference signals on shielded cables



Technical data					
Article	CDN XX	USB 2.0-Z	USB 2.0-Z_10	USB 2.0-P	USB 2.0-P_10
RF In					
Frequency range (RF In)		150 kHz - 230 MHz	10 kHz - 230 MHz	150 kHz - 230 MHz	10 kHz - 230 MHz
Power rating (RF In)		6 W	6 W	6 W	6 W
Decoupling attenuation (RF In – AE)		> 50 dB (150 kHz - 80 MHz) > 25 dB (80 MHz - 230 MHz)			
Insertion loss (RF In – EUT)		10 dB ± 1 dB (150 kHz - 80 MHz) 10 dB + 3 dB (80 MHz - 230 MHz)			
Connector		BNC	BNC	BNC	BNC
EUT / AE					
Max. input voltage		100 VAC / 150 VDC	100 VAC / 150 VDC	100 VAC / 150 VDC	100 VAC / 150 VDC
Current rating (AE – EUT)		0,5 A	0,5 A	0,5 A	0,5 A
Insertion loss (AE – EUT)		< 1 dB (DC - 10 MHz) < 10 dB (10 MHz - 500 MHz)			
Connectors: USB socket		EUT: USB type B AE: USB type A	EUT: USB type B AE: USB type A	EUT: USB type A AE: USB type B	EUT: USB type A AE: USB type B
Mechanical data					
Dimensions (W x H x D)		160 x 84.5 x 240 mm (case size 1)			

Circuit diagram

Circuit diagram

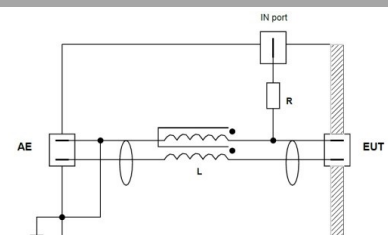

CDN

Coupling / Decoupling Network

CDN

USB-3.0 / -Z / -Z_10 / -P / -P_10

- Coupling / decoupling of interference signals on shielded cables



CDN USB-3.0-P type A)



CDN USB-3.0-Z (type B)

CDN USB (type A)



Technical data					
Article	CDN XX	USB 3.0-Z	USB 3.0-Z_10	USB 3.0-P	USB 3.0-P_10
RF In					
Frequency range (RF In)		150 kHz - 230 MHz	10 kHz - 230 MHz	150 kHz - 230 MHz	10 kHz - 230 MHz
Power rating (RF In)		6 W	6 W	6 W	6 W
Decoupling attenuation (RF In – AE)		> 50 dB (150 kHz - 80 MHz) > 25 dB (80 MHz - 230 MHz)			
Insertion loss (RF In – EUT)		10 dB ± 1 dB (150 kHz - 80 MHz) 10 dB + 3 dB (80 MHz - 230 MHz)			
Connector		BNC	BNC	BNC	BNC
EUT / AE					
Max. input voltage		100 VAC / 150 VDC	100 VAC / 150 VDC	100 VAC / 150 VDC	100 VAC / 150 VDC
Current rating (AE – EUT)		0,9 A	0,9 A	0,9 A	0,9 A
Insertion loss (AE – EUT)		< 1 dB (DC - 10 MHz) < 10 dB (10 MHz - 500 MHz)			
Connectors: USB socket		EUT: USB type B AE: USB type A	EUT: USB type B AE: USB type A	EUT: USB type A AE: USB type B	EUT: USB type A AE: USB type B
Mechanical data					
Dimensions (W x H x D)		160 x 84.5 x 240 mm (case size 1)			

Circuit diagram

Circuit diagram

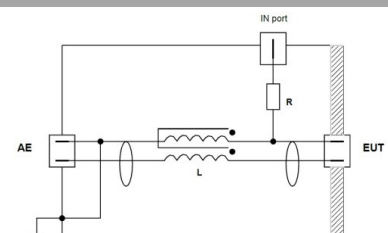

CDN

Coupling / Decoupling Network

CDN USB Type-C / -C_10

- Coupling / decoupling of interference signals on shielded cables

CDN USB (Type-C)



Technical data			
Article	CDN XX	USB Type-C	USB Type-C_10
RF In			
Frequency range (RF In)		150 kHz - 230 MHz	10 kHz - 230 MHz
Power rating (RF In)		6 W	6 W
Decoupling attenuation (RF In – AE)		> 50 dB (150 kHz - 80 MHz) > 25 dB (80 MHz - 230 MHz)	> 50 dB (150 kHz - 80 MHz) > 25 dB (80 MHz - 230 MHz)
Insertion loss (RF In – EUT)		10 dB ± 1 dB (150 kHz - 80 MHz) 10 dB + 3 dB (80 MHz - 230 MHz)	10 dB ± 1 dB (150 kHz - 80 MHz) 10 dB + 3 dB (80 MHz - 230 MHz)
Connector		BNC	BNC
EUT / AE			
Max. input voltage		100 VAC / 150 VDC	100 VAC / 150 VDC
Current rating (AE – EUT)		0,9 A	0,9 A
Insertion loss (AE – EUT)		< 1 dB (DC - 10 MHz) < 10 dB (10 MHz - 500 MHz)	< 1 dB (DC - 10 MHz) < 10 dB (10 MHz - 500 MHz)
Connectors: USB socket		EUT: USB Type-C AE: USB Type-C	EUT: USB Type-C AE: USB Type-C
Mechanical data			
Dimensions (W x H x D) (Case size 1)		160 x 84.5 x 240 mm	160 x 84.5 x 240 mm

Circuit diagram

Circuit diagram

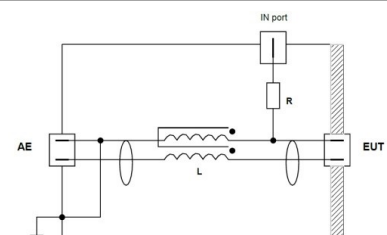

CDN

Coupling / Decoupling Network

Calibration adaptor – Order number (Only needed on EUT-side!)

CDN-type	Article
USB-P adapted for CDN USB-2.0-P CDN USB-2.0-P_10 CDN USB 3.0-P CDN USB 3.0 P-10	CDG A 3122 (type A)
USB-Z adapted for CDN USB-2.0-Z CDN USB-2.0-Z_10 CDN USB 3.0-Z CDN USB 3.0 Z-10	CDG A 3121 (type B)
USB Type-C USB Type C_10	CDG A 3146 (type-C)
Mounting plate with 50/150 Ohm adaptor	CDG A 3100

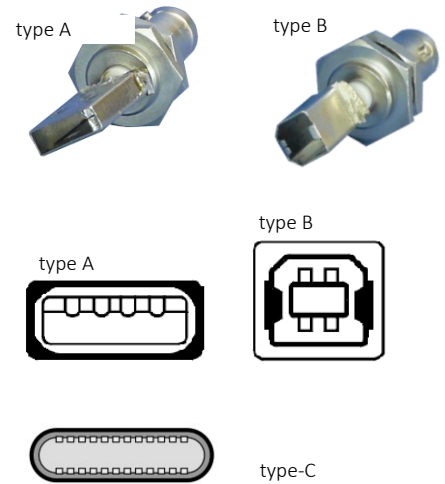

CDN

Coupling / Decoupling Network

CDN D 100

- Device for direct coupling
100 Ω Connection for RF disturbance variables 10 kHz - 230 MHz

Including calibration adaptor

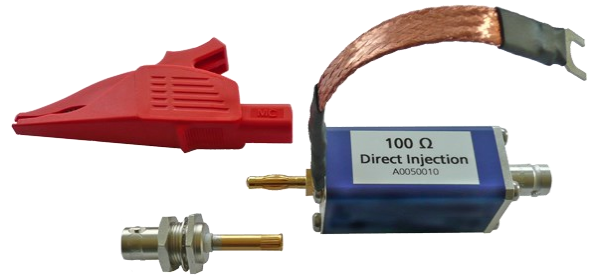

Overview

The interference signal coming from the test generator is fed into shielded and coaxial cables via a 100 Ω resistor (even if the shield is ungrounded or grounded at one end only).

A decoupling device must be inserted between the additional/auxiliary equipment and the feed-in point as close as possible to the feed-in point.

To increase decoupling and stabilize the circuit, a ground connection must be made from the shield of the input of the device used for direct coupling to the reference ground plane. This connection is made on the side of the supply unit where the auxiliary device is connected.

Technical data

Article	CDN D 100
RF In	
Frequency range (RF In)	10 kHz 230 MHz
Power rating (RF In)	6 W (continuous)
Common mode impedance (IN/OUT)	100 Ω
EUT / AE	
Connector In	BNC
Connector Out	Alligator clip; max. cable diameter 30 mm



CDN

Coupling / Decoupling Network

Calibration CDN D 100

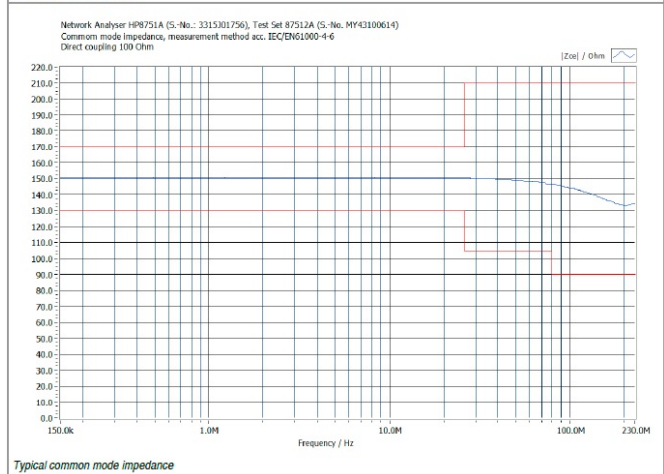
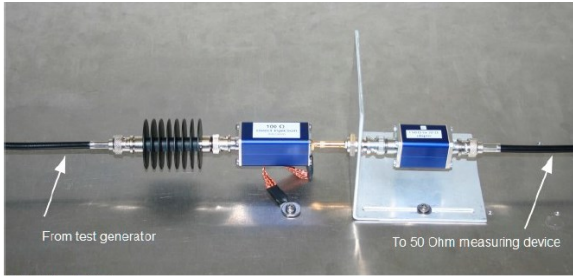

Technical drawing

Case size 1

All Types without M-types > 32 A

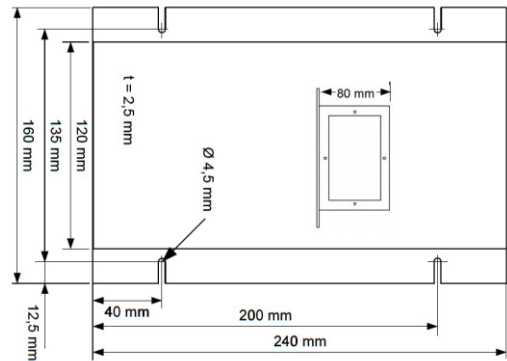
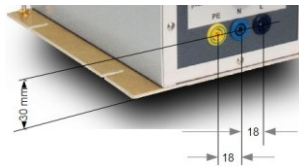

Case size 2

Only M-types > 32 A

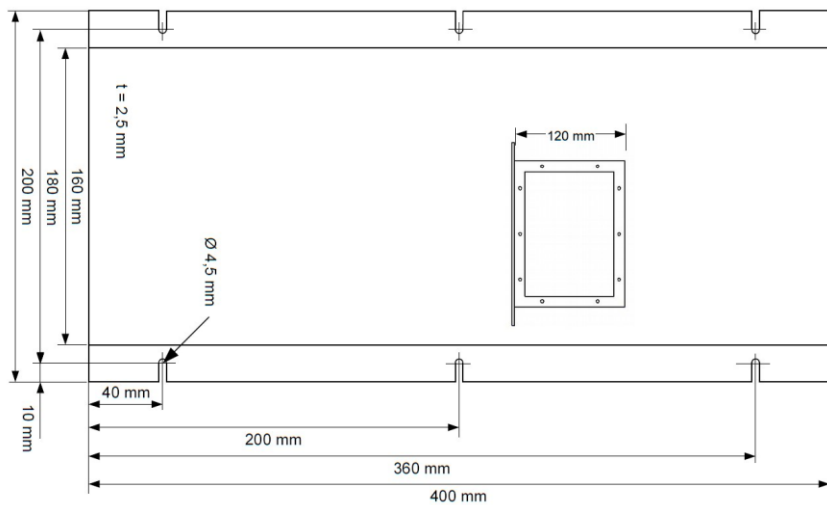

CDN

Coupling / Decoupling Network

Accessories for calibration set I

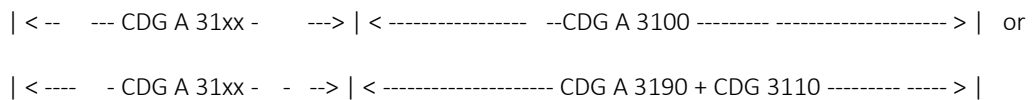
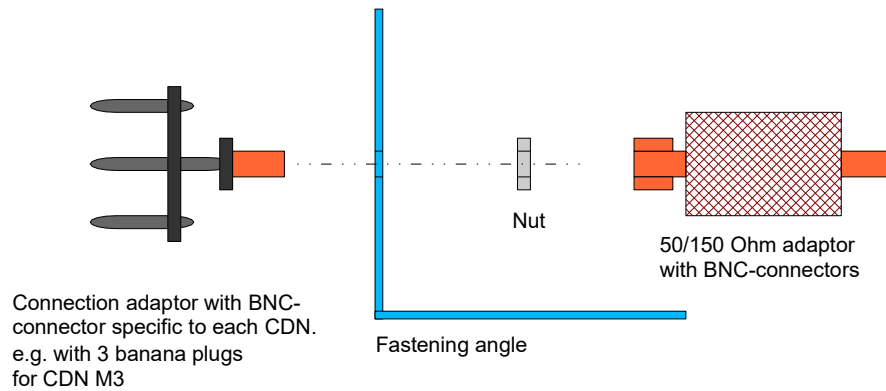

To calibrate a coupling network (CDN), the following elements are required (AE and EUT side)*:

- 2x CDG A 31xx (corresponding CDN connection adaptors for AE and EUT side)
- 2x CDG A 3100 (mounting plate + 50/150 Ohm transition + 50 Ohm termination for AE side) or
- 2x CDG A 3190 (mounting plate + 50 Ohm termination for AE side) +
- 2x CDG 3110 (50/150 Ohm adaptor)

The following is required for the first coupling network*:

- 2 x CDG A 31xx +
- 2 x CDG A 3100 or 2x (CDG A 3190 + CDG 3110)

For each additional coupling network, only two corresponding connection adaptors must be ordered*:

- 2 x CDG A 31xx, optional for one connection adaptor each also a mounting bracket CDG A 3190

**Depending on the signal, termination can be omitted on the AE side. Let us advise you on the details.*

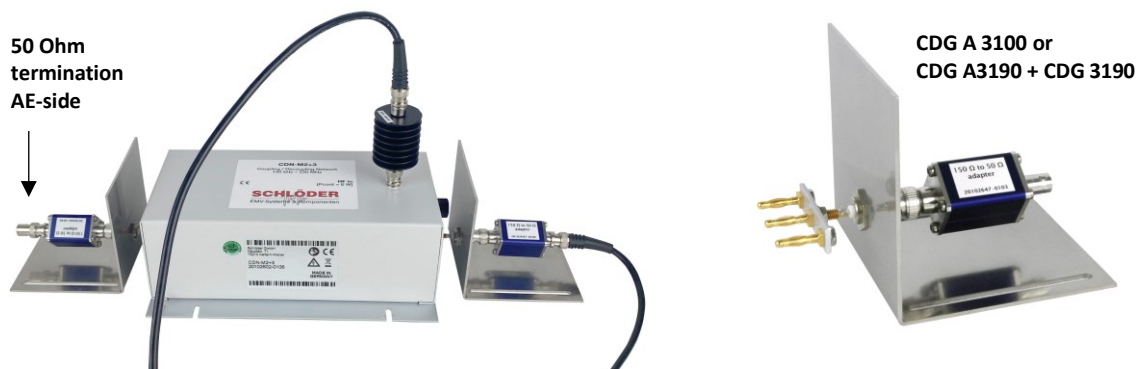

CDN

Coupling / Decoupling Network

Accessories for calibration set II

Mounting plate CDG A 3190
(incl. 50 Ohm termination)
2,5 mm aluminium

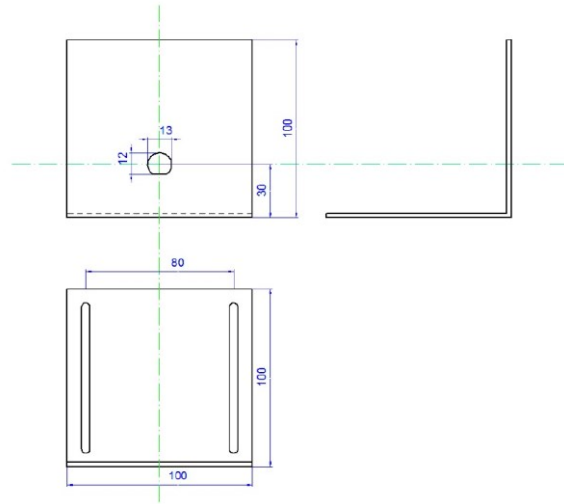

Insertion loss 150 Ohm to 50 Ohm adaptor (two in series)

Network Analyser HP8751A (S.-No.: 3315101756), Test Set 87512A (S.-No. MY43100614)
Insertion loss 150/50 Ohm Adaptor (two in series)

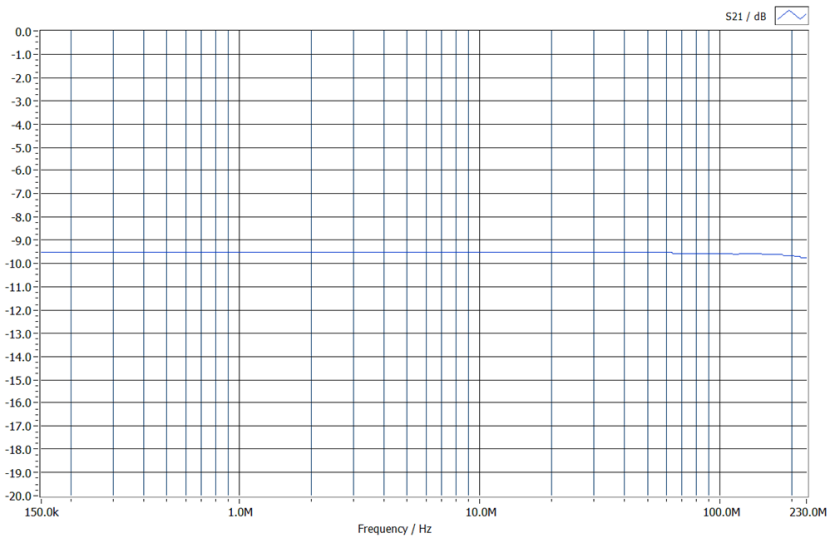

All information regarding appearance and technical data correspond to the current state of development at the time of release of this data sheet. We reserve the right to make technical changes. 112305

